



PROMAX

Sun-Moon Industrial Co.,Ltd.

11F Block A, Zhongti CENTER, No. 299 Kangzhuang South Road, Jiangbei District,
Ningbo, 315033 China.

Tel: +86-574-8388 3666

E-mail: sales@sunmoon-tools.com

PROMAX

CORDLESS TOOLS

CATALOGUE 2023

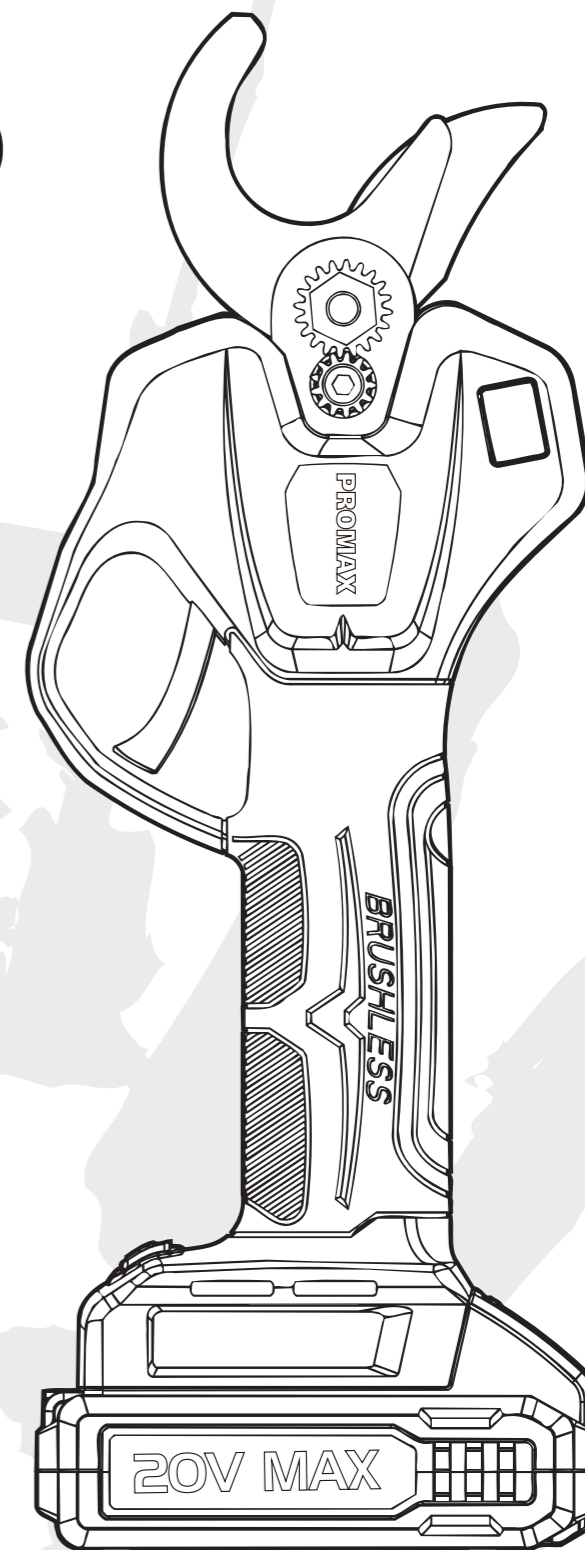

www.sunmoon-tools.com

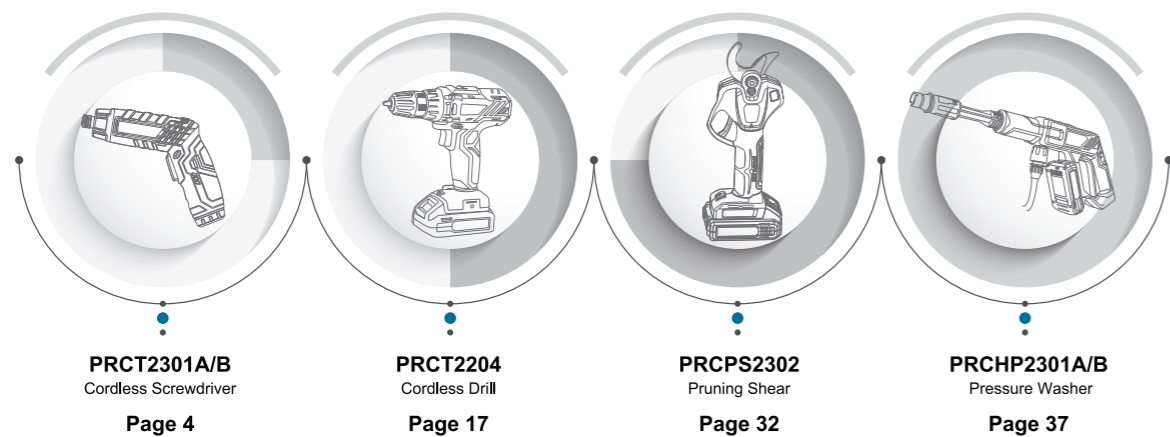

PRCT2301A/B
Cordless Screwdriver
Page 4

PRCT2204
Cordless Drill
Page 17

PRCPS2302
Pruning Shear
Page 32

PRCHP2301A/B
Pressure Washer
Page 37

 PRCT2301A/B Cordless Screwdriver	 PRCT2106 Cordless Screwdriver	 PRCT2303 Cordless Screwdriver	 PRCT2105 Cordless Screwdriver	 PRCT2302 Cordless Screwdriver	 PRCT2304 Cordless Screwdriver	 PRCT2311 Cordless Mini Grinder
 PRCT2312 Cordless Mini Grinder	 PRCT2321 Heating Glue Pen	 PRCT2322 Multi-function Heating Pen	 PRCGT1625 Shrub&Grass Trimmer 2 In 1	 PRCGT2005 Shrub&Grass Trimmer 2 In 1	 PRCT2331 Cordless Drill/Driver	 PRCT2332 Cordless Hammer Drill
 PRCT2333 Cordless Drill/Driver	 PRCT2334 Cordless Impact Driver	 PRCT2335 Cordless Drill/Driver	 PRCPS2301 Pruning Shear	 PRCT1904 Reciprocating Saw	 PRCCS2301 Mini Chain Saw	 PRCT2204 Cordless Drill
 PRCT2207 Cordless Hammer Drill	 PRCT1618 Cordless Hammer Drill	 PRCT2341 Rotary Hammer	 PRCT2342 Reciprocating Saw	 PRCT1823 Cordless Angle Grinder	 PRCT2343 Cordless Impact Driver	 PRCT2344 Ratchet Wrench
 PRCT2345 Impact Wrench	 PRCT2206 Rotary Sander	 PRCT2346 Cordless Belt Sander	 PRCT2205 Cordless Jig Saw	 PRCT1822 Cordless Circular Saw	 PRCT2347 Reciprocating Saw	 PRCT2348 Cordless Planer
 PRVC2301 Vacuum Cleaner	 PRVC2302 Vacuum Cleaner	 PRVC2009 Vacuum Cleaner	 PRVC2303 Ash Cleaner	 PRCT1835 Cordless Spray Gun	 PRCGT2001 Long Pole Chain Saw	 PRCCS2302 Cordless Chain Saw
 PRCPS2302 Pruning Shear	 PRCGT1902A/B String Trimmer	 PRCHT1901 Hedge Trimmer	 PRCHT1902 Hedge Trimmer	 PRCGT2002 Long Pole Hedge Trimmer	 PRCBL2301 Cordless Blower	 PRCBL2302 Cordless Blower
 PRCHP2301A/B Pressure Washer	 PRCCS4001 Cordless Chain Saw	 PRCBV4001 Blower Vacuum	 PRCBC4001 2 In 1 Brush Cutter	 PRCLM4001 Cordless Lawn Mover	 PRCSC4001 Cordless Scarifier	 PRCCU4001 Cordless Cultivator

COMPANY OVERVIEW

Focus All Quality Hardware Tools

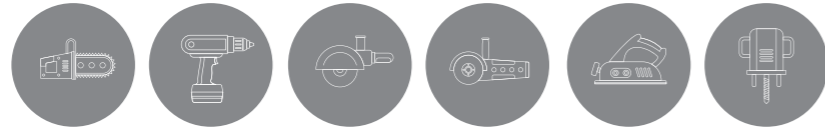

Sun-Moon Industrial Co., Ltd was established in 1998 and growth to one of the biggest TOOL suppliers in China.

We source our products from well know manufactures in China and we also have our own factory which produce power tools and garden tools.

With the extensive support from R&D, total quality management, all our products have complied with the global qualified standard.

We not only do OEM and ODM business with 150+ customers all over the world, but also supply our own MAXPRO brand tool to different countries.



20000 m²
Factory area



10+ person
R&D engineers



20+ person
Quality control person



150+
Customers all over the world



8-12
New products per year in factory

OUR BRANDS



MAXPRO-----We supply our own MAXPRO brand professional tools all over the world from year 2012. We keep stock by ourselves in NINBGO warehouse to make quick delivery and we accept small MOQ to reduce our partner s inventory level. Welcome to become our Agent

www.maxpro-tools.com



PROMAX-----This brand grows with the SUN-MOON company together from 1998, we do OEM and ODM business of power tools, garden tools and hand tools for more than 24 years. We use PROMAX brand to show our products in showroom and exhibition.

www.sunmoon-tools.com



KREBS-----Inspire the Different. This distinctive KREBS brand was recognized in 1946 in SWISS. Welcome to visit our Amazon Japan and USA shop to check and buy different kind of tools. KREBS will be your good choice.

Amazon shop

MANUFACTURING BASE

We source our product from well know manufactures in China and we also own our own factory which cover 20,000 m² for designing, testing and manufacture high quality products. Our facility allows us to produce according the highest standards our customer requires for.



QUALITY CONTROL

Our professional quality management and inspection team will strictly control the quality of all our products. Our factory at Ningbo China has a wide range of test equipment to control and maintenance the quality of our products.



SERVICE

We offer our customer a wide range of service facility's like Technical support, providing spare parts,loading supervisor.



3.6V / CORDLESS SCREWDRIVER

PRCT2301A/PRCT2301B

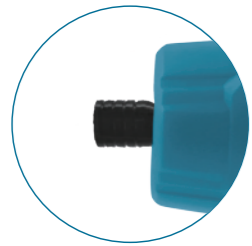

PRCT2301B
(Quick releasing chuck)



5
N.m
Max.torque

Forwarding
reversing

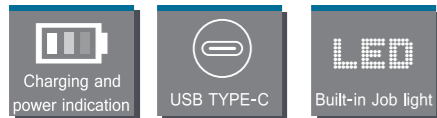

SPECIFICATION	ART NO.PRCT2301A	ART NO.PRCT2301B
Voltage	3.6 V	3.6 V
Motor	#380	#380
Battery capacity	1300 mAh	1300 mAh
Charger	USB type-C	USB type-C
No load speed	230 rpm	230 rpm
Max torque	5 N.m	5 N.m
LED front working light	3 LED	3 LED
LED flash light function	Yes	Yes
Chuck	6.35mm hexagonal magnetic bit chuck	6.35mm quick releasing chuck

3.6V / CORDLESS SCREWDRIVER

PRCT2106



3
N.m
Max.torque

Forwarding
reversing

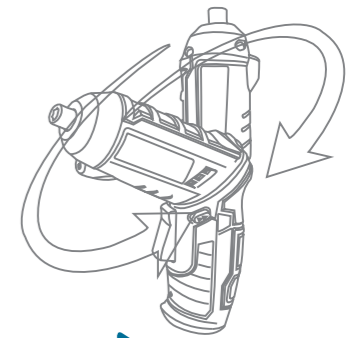
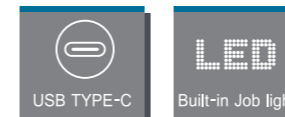

SPECIFICATION	ART NO.PRCT2106
Voltage	3.6 V
Motor	#380
Battery capacity	1300 mAh
Charger	USB type-C
No load speed	250 rpm
Chuck	6.35 mm hexagonal magnetic bit chuck
Max torque	3 N.m
LED front working light	Yes

3.6V / CORDLESS SCREWDRIVER

PRCT2303



- 5 N.m Max.torque
- Torque setting 3
- Forwarding reversing
- Charging and power indication
- USB TYPE-C
- Built-in Job light

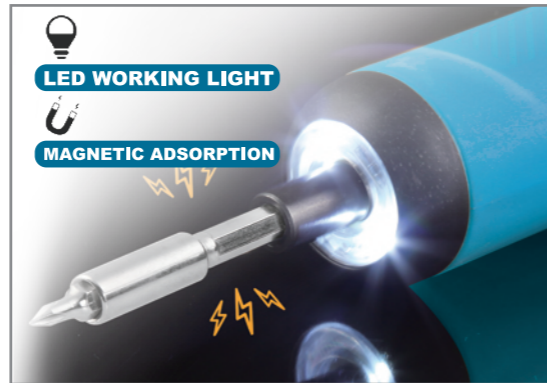

SPECIFICATION	ART NO.PRCT2303
Voltage	3.6 V
Motor	#380
Battery capacity	1300 mAh
Charger	USB type-C
No load speed	250 rpm
Max torque	5 N.m
LED front working light	2 LED
Torque setting	Yes
Chuck	6.35 mm hexagonal magnetic bit chuck

3.6V / CORDLESS SCREWDRIVER

PRCT2105



SPECIFICATION	ART NO.PRCT2105
Voltage	3,6 V
Motor	#380
Battery	1300 mAh
Charger	Micro USB Type-B
No load speed	180 rpm
Max torque	4 N.m
Chuck	6.35 mm
LED working light	2 LED

PRCT2302



SPECIFICATION	ART NO.PRCT2302
Voltage	3,6 V
Motor	#180
Battery	900 mAh
Charger	Micro USB Type-B
No load speed	270 rpm
Max torque	3.5 N.m/8 N.m
Chuck	6.35 mm
LED working light	1 LED

PRCT2304



SPECIFICATION	ART NO.PRCT2304
Voltage	3,6 V
Motor	#N20
Battery	260 mAh
Charger	MicroUSB Type-B
No load speed	120 rpm
Max torque	0.15 N.m
Chuck	4 mm

3.6V / CORDLESS MINI GRINDER

PRCT2311



3.6V / CORDLESS MINI GRINDER

PRCT2312

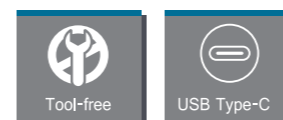

SPECIFICATION	ART NO.PRCT2311
Voltage	3.6 V
Battery capacity	600 mAh
Charger	Micro USB Type-B
No load speed	5000 / 10000 / 15000 rpm
Chuck	2.3 mm

SPECIFICATION	ART NO.PRCT2312
Voltage	3.6 V
Battery capacity	2000 mAh
Charger	USB type-C
No load speed	5000-25000 rpm
Chuck	3.2 mm

3.6V / CORDLESS HEATING GLUE PEN MULTI-FUNCTION HEATING PEN

PRCT2321

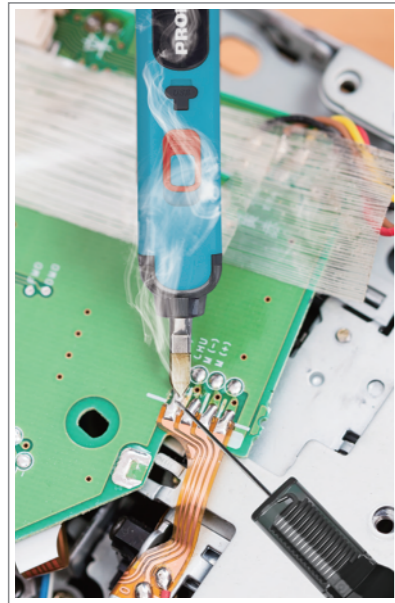
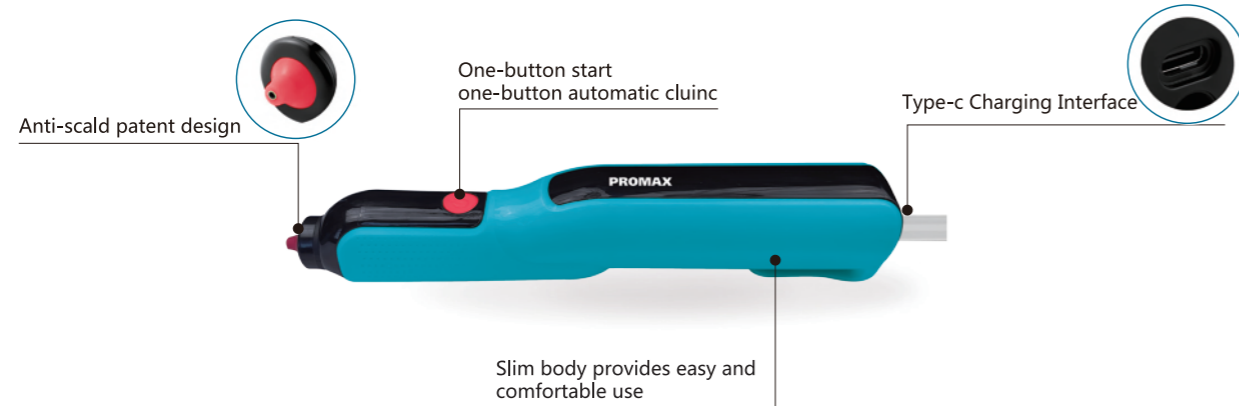
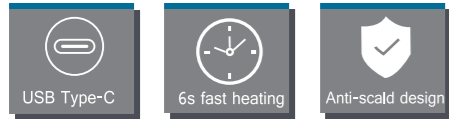

PRCT2322

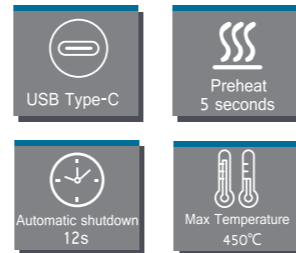

3.6V/7.2V / CORDLESS SHRUB & GRASS TRIMMER 2 IN 1

PRCGT1625

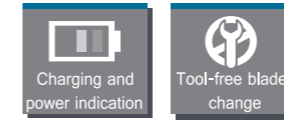

PRCGT2005 Extension handle

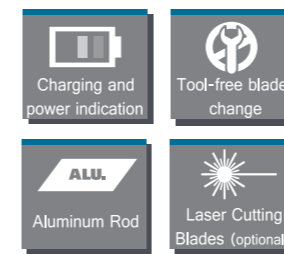

SPECIFICATION	ART NO.PRCT2321	SPECIFICATION	ART NO.PRCT2322
Voltage	3.6 V	Voltage	3.6 V
Battery capacity	2000 mAh	Battery capacity	2000 mAh
Charger	USB type-C	Charger	USB type-C
Pre-heating time	6 Seconds	Max temperature	450°C
Nozzle temperature	150-180°C	Preheat time	5s
Diameter of glue stick	7 mm	Automatic shutdown	12s

SPECIFICATION	ART NO.PRCGT1625	ART NO.PRCGT2005
Voltage	3.6 V	7.2 V
Motor type	#380	#380
Battery capacity	1300 mAh	1300 mAh
No load speed	1100 rpm	1100 rpm
Teeth distance of shrub trimmer	8mm	8mm
Blade width of grass trimmer	80mm	90mm
Cutting length of shrub trimmer	120mm	120mm

12V MAX / CORDLESS DRILL/DRIVER

PRCT2331

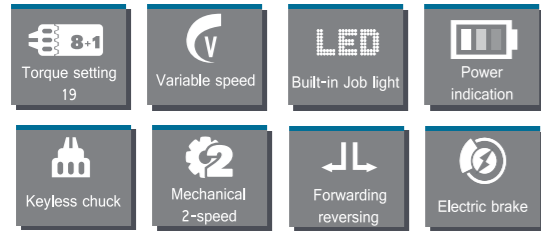

PRCT2332

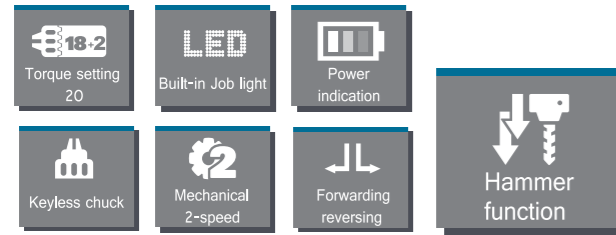

PRCT2333

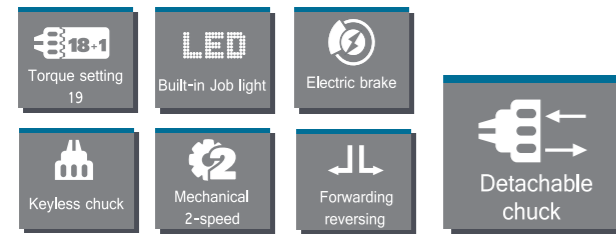

SPECIFICATION	ART NO.PRCT2331	ART NO.PRCT2332	ART NO.PRCT2333
DC voltage	12 V max	12 V max	12 V max
Motor type	#550	#550	#550
No load speed	0-350/0-1300 rpm	0-350/0-1300 rpm	0-350/0-1300 rpm
Impact rate	N/A	0-5250/0-19500 bpm	N/A
Max torque	26 N.m	26 N.m	26 N.m
Max chuck size	ø10mm keyless chuck	ø10mm keyless chuck	ø10mm keyless chuck
Drill diameter in steel	8 mm	8 mm	8 mm
Drill diameter in wood	20 mm	20 mm	20 mm

12V MAX / CORDLESS IMPACT DRIVER CORDLESS DRILL/DRIVER

PRCT2334

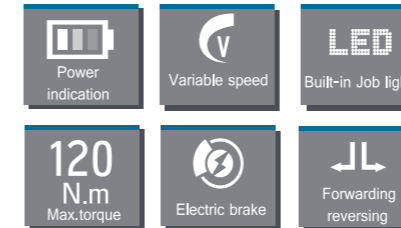

PRCT2335

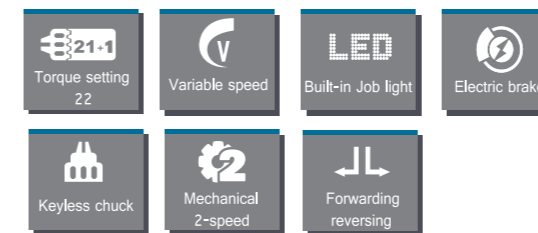

SPECIFICATION	ART NO.PRCT2334
Voltage	12 V max
Motor	#550
No load speed	0-2200 rpm
Impact rate	0-2800 bpm
Max torque	120 N.m
Hex shank	6.35mm (1/4")hex

SPECIFICATION	ART NO.PRCT2335
Voltage	12 V max
Motor	#550
No load speed	0-400 / 0-1500 rpm
Chuck	10mm keyless chuck
Torque setting	21+1
Max torque	23 N.m

12V MAX / CORDLESS PRUNING SHEAR

PRCPS2301

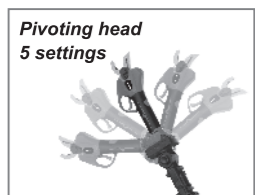
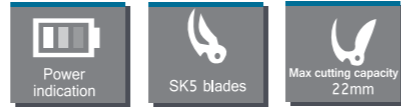

(Long pole 1m-3m optional)
Suitable For Both PRCCS2301 Chain Saw And PRCPS2301 Pruning Shear



- Avoid the blade stuck on the branch
- Blade's non-slip design to make cutting faster and easier

SPECIFICATION	ART NO.PRCPS2301
Voltage	12 V max
Motor	#390
No load speed	(16mm)37cuts/min (22mm)31cuts/min
Max cutting capacity	ø22 mm
Adjustable opening	16-22 mm
Cutting speed	(16mm wood)30cuts/min (22mm wood)24cuts/min

12V MAX / CORDLESS RECIPROCATING SAW MINI CHAIN SAW

PRCT1904

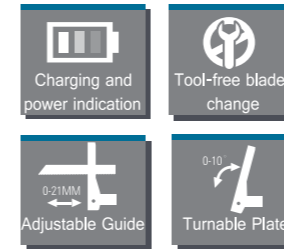

4-stage sliding guide for higher blade utilization

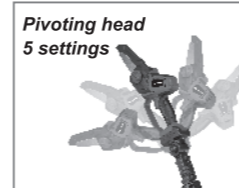

(Long pole 1m-3m optional)
Suitable For Both PRCCS2301 Chain Saw And PRCPS2301 Pruning Shear

PRCCS2301

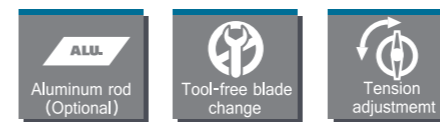

SPECIFICATION	ART NO.PRCT1904
Voltage	12 V max
Motor type	#550
Stroke length	13 mm
No load speed	0-2200 rpm
Max Cutting Ability	Branch ø55mm PVC tube ø55-60mm

SPECIFICATION	ART NO.PRCCS2301
Voltage	12 V max
Motor type	#550
Bar length	4"
Chain speed	4 m/s
Chain pitch	1/4"

PROMAX

BATTERY PLATFORM

20+ 1x20V Power Tools

16+ 1x20V/2x20V Garden



20V MAX CORDLESS DRILL CORDLESS HAMMER DRILL

PRCT2204

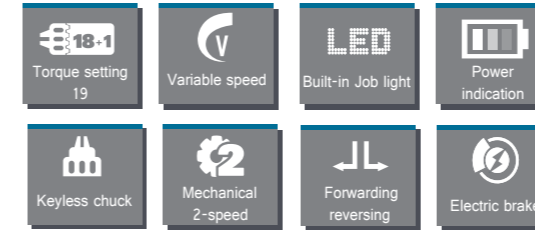

PRCT2207

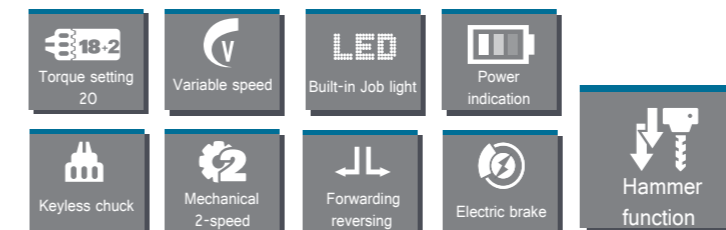

SPECIFICATION	ART NO.PRCT2204	ART NO.PRCT2207
Voltage	20 V max	20 V max
No load speed	0-350/0-1300 rpm	0-350/0-1300 rpm
Impact rate	N/A	0-5250/0-19500 bpm
Motor	#550	#550
Chuck	10mm keyless chuck	10mm keyless chuck
Max torque	32 N.m	32 N.m
Torque setting	18+1	18+2
Battery indicator	Yes	Yes

20V MAX

**CORDLESS HAMMER DRILL
CORDLESS ROTARY HAMMER**

PRCT1618

- Torque setting 20
- Variable speed
- Built-in Job light
- Power indication
- 13mm Metal keyless chuck
- Mechanical 2-speed
- Forwarding reversing
- Electric brake
- Hammer function

Steel 13 mm | Wood 32 mm | Concrete 12 mm



PRCT2341

- Variable speed
- Forwarding reversing
- Built-in Job light
- Power indication
- Hammer function

Steel 10 mm | Concrete 13 mm | 2 Function Drill, Hammer | SDS plus

SPECIFICATION	ART NO.PRCT1618	ART NO.PRCT2341
DC Voltage	20 V max	20 V max
Motor type	#775	#750
No load speed	0-400/0-1400 rpm	0-850 rpm
Impact rate	0-6400/0-22400 bpm	0-5500 bpm
Max impact energy	N/A	1.3 J
Max. torque	45 N.m	N/A
Chuck	ø13mm metal keyless chuck	N/A

20V MAX

CORDLESS ANGLE GRINDER

BRUSHLESS MOTOR
HIGH EFFICIENCY SUPER QUALITY

Brushless Motor

PRCT2342

- Charging and power indication
- Electric brake
- Soft start (Optional)



PRCT1823

- Charging and power indication
- Electric brake
- Soft start (Optional)

SPECIFICATION	ART NO.PRCT2342	ART NO.PRCT1823
DC Voltage	20 V max	20 V max
Motor type	Brushless	#885
No load speed	8500 rpm	8500 rpm
Disc size	ø115/125 mm	ø115/125 mm

20V MAX

**CORDLESS IMPACT DRIVER
CORDLESS RATCHET WRENCH**

PRCT2343

- Power indication
- Variable speed
- LED Built-in Job light
- 140 N.m Max.torque
- Electric brake
- Forwarding reversing

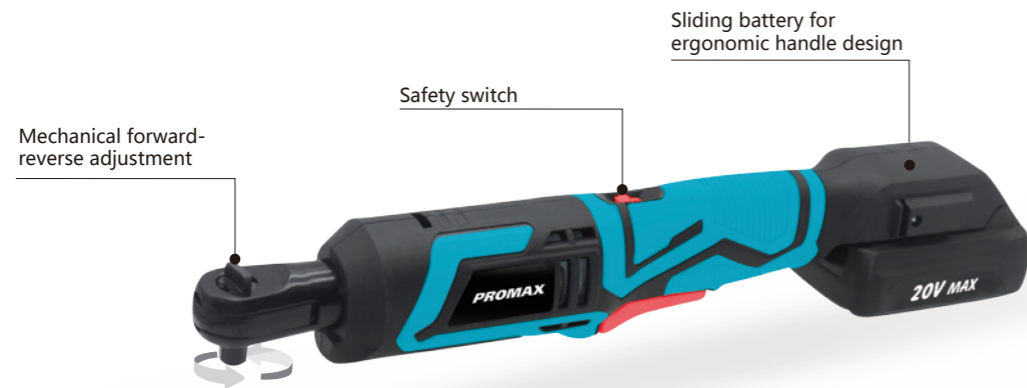

PRCT2344

- 40 N.m Max.torque
- Power indication
- Forwarding reversing

SPECIFICATION	ART NO.PRCT2343	ART NO.PRCT2344
DC Voltage	20 V max	20 V max
Motor type	#550	#550
No load speed	0-2200 rpm	250 rpm
Impacts per minute	0-2800 bpm	N/A
Max.fastening torque	140Nm	40Nm
Hex shank	6.35mm hex	N/A
Anvil size	N/A	9.5 mm
Capacity	Standard bolt M4-M12	Standard bolt M5-M12

20V MAX

CORDLESS IMPACT WRENCH

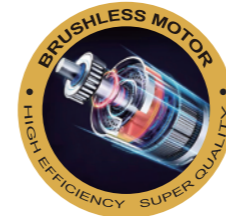

Brushless Motor

PRCT2345

- Power indication
- Variable speed
- LED Built-in Job light
- 350 N.m Max.torque
- Electric brake
- Forwarding reversing

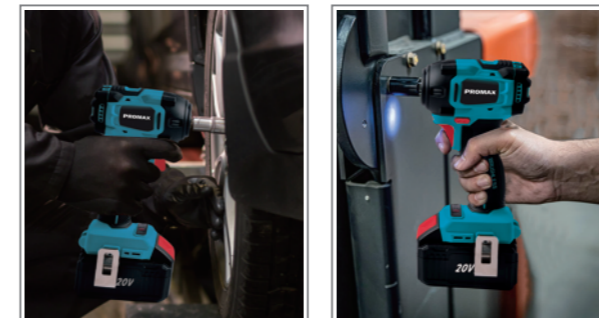

Aluminium head with cover

2-stage torque control & reverse quick-braking function



SPECIFICATION	ART NO.PRCT2345
DC Voltage	20 V max
Motor type	Brushless motor
No load speed	0-2800 rpm
Impacts per minute	0-3500 bpm
Max. fastening torque	210/350 N.m
Anvil size	12.7 mm

20V MAX

**CORDLESS ROTARY SANDER
CORDLESS BELT SANDER**

Ergonomically designed handle with soft grip

Dust proof switch



PRCT2206

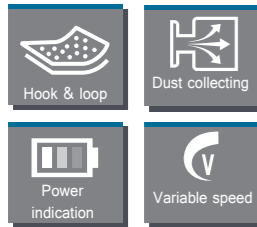

PRCT2346

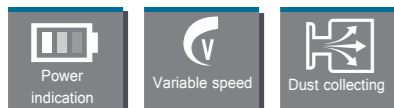

SPECIFICATION	ART NO.PRCT2206
DC Voltage	20 V max
Motor type	#755
No load speed	6000-11000 rpm
Pad size	ø125 mm
SPECIFICATION	ART NO.PRCT2346
DC Voltage	20 V max
Motor type	#897
Belt speed	120-350 m/min
Belt size	76x457 mm

20V MAX

**CORDLESS JIG SAW
CORDLESS CIRCULAR SAW**

PRCT2205

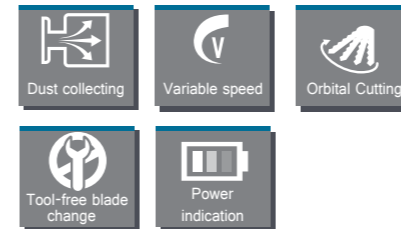

Ergonomically designed handle with soft grip

PRCT1822

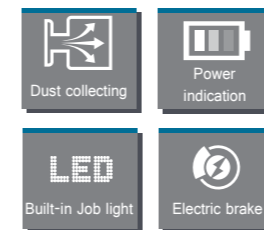

Rear dust exhaust port

Bevel cuts up to 50 degrees

SPECIFICATION	ART NO.PRCT2205
DC Voltage	20 V max
Motor type	#775
No load speed	0-2800 rpm
Stroke	25 mm
Max. cutting capacity	65mm for wood; 8mm for metal
SPECIFICATION	ART NO.PRCT1822
DC Voltage	20 V max
Motor type	#885
No load speed	3700 rpm
Blade size	165mm
Max. cutting depth	0° 56mm 45° 40mm 50° 36mm

20V MAX / CORDLESS RECIPROCATING SAW CORDLESS PLANER



PRCT2347



PRCT2348

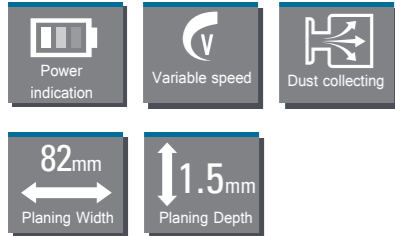

SPECIFICATION	ART NO.PRCT2347
DC Voltage	20 V max
Motor type	#785
No load speed	0-2800 rpm
Cutting stroke	26 mm
Max.cutting capacity	Wood:115mm Metal:5mm
SPECIFICATION	ART NO.PRCT2348
DC Voltage	20 V max
Motor type	#897
No load speed	16000 rpm
Planing width	82 mm
Planing depth	0-1.5 mm
Rebate capacity	0-8 mm

20V MAX / CORDLESS VACUUM CLEANER

PRVC2301

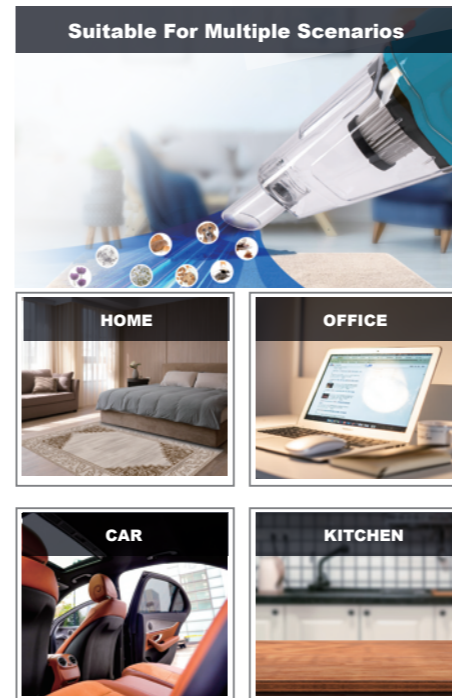

High effective filtration system

SPECIFICATION	ART NO.PRVC2301
DC Voltage	20 V max
Motor	#545
Air flow rate	12 L/S
Vacuity	≥10 KPA

20V MAX

CORDLESS WET&DRY VACUUM CLEANER
PRVC2302



Brushless Motor (Optional)



Washable HEPA filter with efficient filtration



Covert storage of accessories



Waterproof structure for guaranteeing security

STANDARD ACCESSORIES



OPTIONAL ACCESSORIES



SPECIFICATION	ART NO.PRVC2302
Voltage	20 V max
Tank size	15 L
Motor	#545
Airflow rate	8 L/S
Vacuity	≥9 KPA

20V MAX

CORDLESS VACUUM CLEANER
ASH CLEANER

PRVC2009

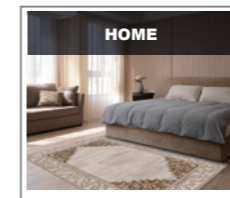
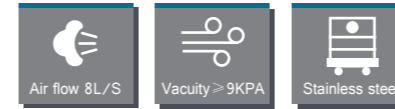

PRVC2303

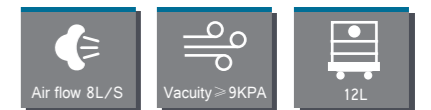

Metal-Lined Hose
Heat Resistant Design to Ensure Safety During Use



SPECIFICATION	ART NO.PRVC2009	ART NO.PRVC2303
DC Voltage	20 V max	20 V max
Tank size	15L stainless steel tank	12 L
Motor	#545	#545
Airflow rate	8 L/S	8 L/S
Vacuity	≥9 KPA	≥9 KPA

20V MAX / CORDLESS SPRAY GUN

PRCT1835

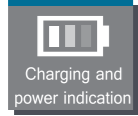
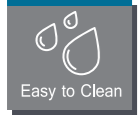

Spray length adjustment

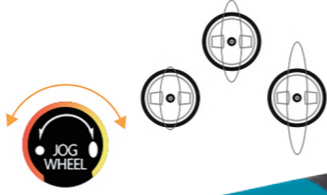

Spray Angle Adjustment



Spray volume adjustment



Complete Adjustability



Adjustable Pattern Width

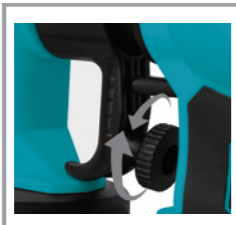

Material Flow Control



Support Multiple Viscosities

SPECIFICATION	ART NO.PRCT1835
Voltage	20 V max
Motor	#550
Nozzle	1.8 mm
Container Volume	700 ml
Max.Water Consumption	350 ml/rpm
Max.Viscosity	80 din-Secs

PROMAX

BATTERY PLATFORM

20+ 1x20V Power Tools

16+ 1x20V/2x20V Garden Tools

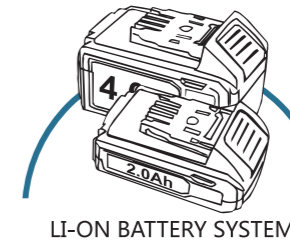

36+



20V MAX

CORDLESS LONG POLE CHAIN SAW

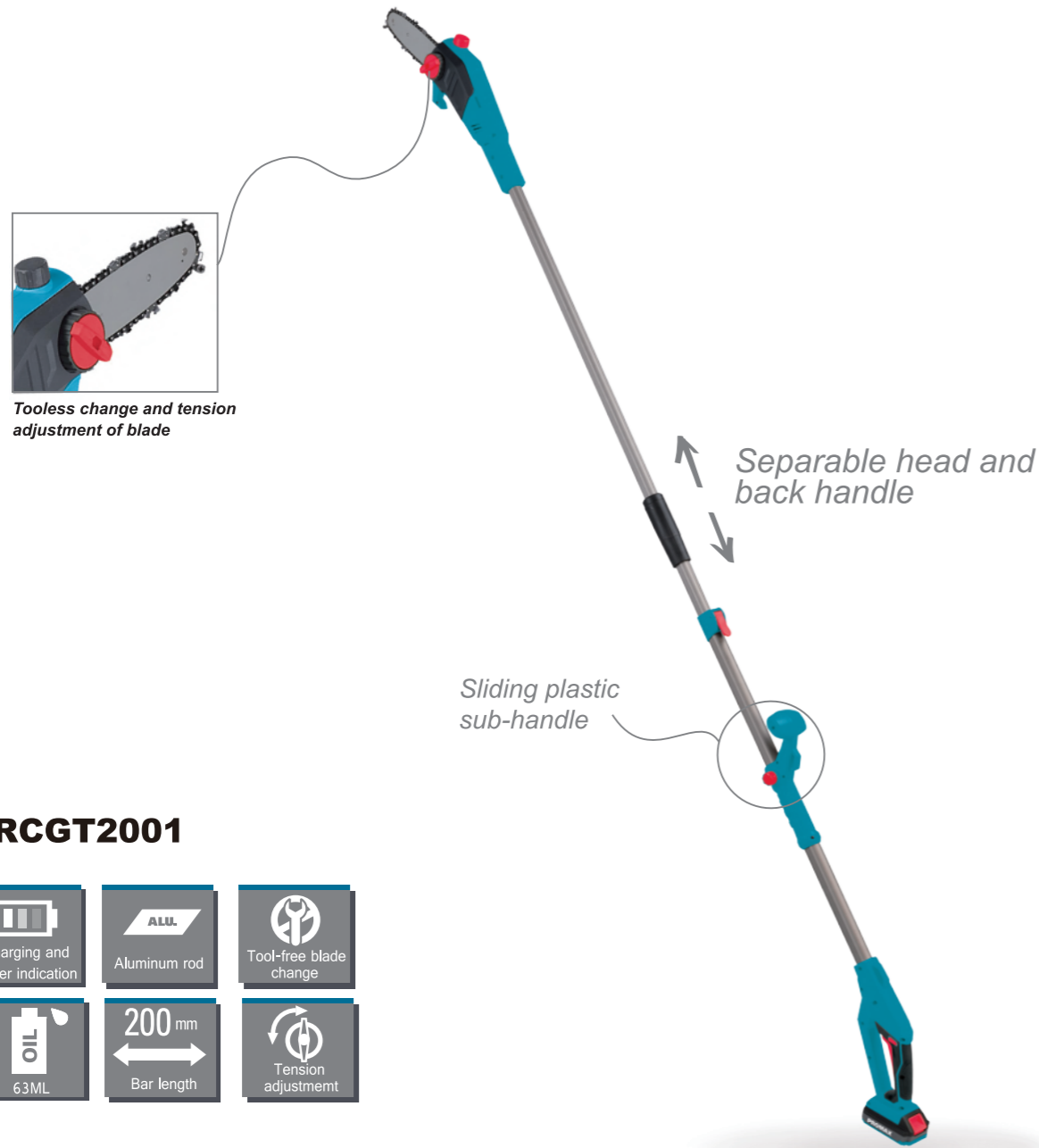

PRCGT2001

- Charging and power indication
- Aluminum rod
- Tool-free blade change
- 63ML
- 200 mm Bar length
- Tension adjustment

SPECIFICATION	ART NO.PRCGT2001
Voltage	20V max
Motor type	#785
Chain speed	4.2 m/s
Blade length	200 mm
Machine length	160-240 cm

20V MAX

CORDLESS CHAIN SAW



Brushless Motor

PRCCS2302

- Auto oiler
- Tension adjustment
- Aluminum rod (Optional)



SPECIFICATION	ART NO.PRCCS2302
Voltage	20 V max
Motor type	Brushless
Bar length	5"/16"
Chain speed	6 m/s
Chain Pitch	1/4"

20V MAX / CORDLESS PRUNING SHEAR

PRCPS2302



- Avoid the blade stuck on the branch
- Blade's non-slip design to make cutting faster and easier

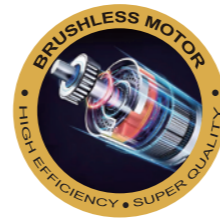

Brushless Motor



LCD screen:
 • % of battery
 • Cutting history
 • No of current cuts
 • Error code

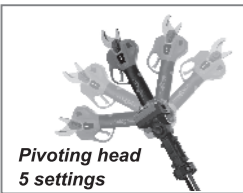

Wide Range Of Applications



- Power indication
- SK5 blades
- Powerful brushless motor
- Max cutting capacity 32mm

(Long pole 1m-3m optional)
 Suitable For Both PRCCS2302 Chain Saw And PRCPS2302 Pruning Shear

SPECIFICATION	ART NO.PRCPS2302
Voltage	20 V max
Motor	Brushless
No load speed	(25mm)76cuts/min (32mm)56cuts/min
Max cutting capacity	ø32 mm
Adjustable opening	25-32 mm
Cutting speed	(25mm wood)54cuts/min (32mm wood)46cuts/min

20V MAX / CORDLESS STRING TRIMMER

PRCGT1902A

- Charging and power indication
- ø1.60mm
- 300mm Cutting width (Line)

PRCGT1902B

- Charging and power indication
- ALU Aluminum rod
- 250mm Cutting width (Blade)



3 in 1

Telescopic pipe shaft adjustable from 1040mm to 1290mm



Adjustable spacer guard protects plants and garden furniture.



Pivoting head from 0° to 90°



SPECIFICATION	ART NO.PRCGT1902A	ART NO.PRCGT1902B
Voltage	20V max	20V max
Motor type	#775	#775
Cutting width	300mm (12")	250mm (10")
No load speed	8000 rpm	8000 rpm

20V MAX / CORDLESS HEDGE TRIMMER

PRCHT1901

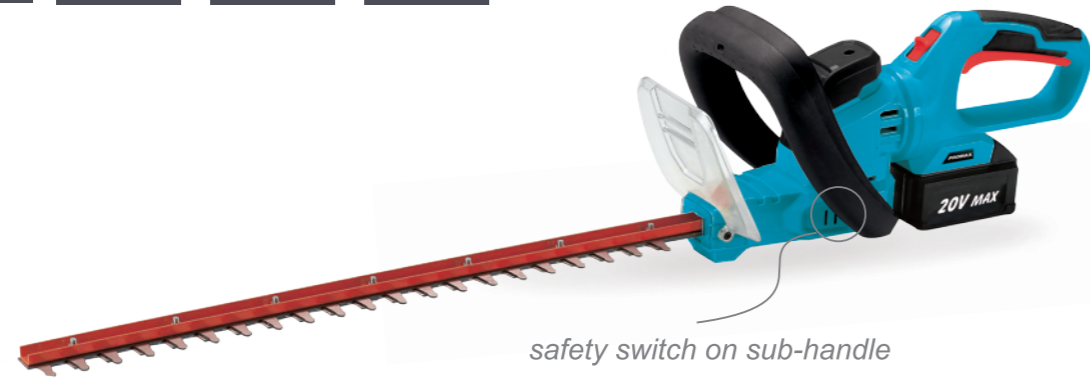
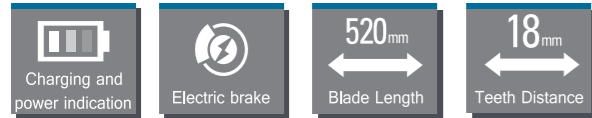

PRCHT1902

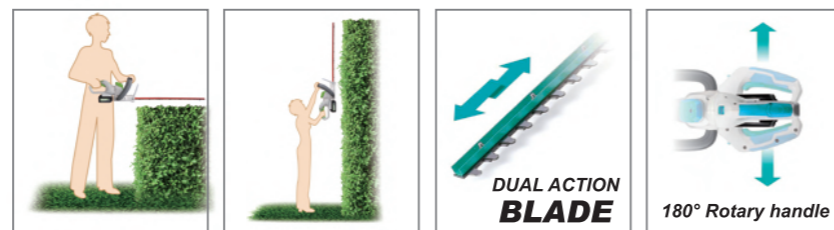

SPECIFICATION	ART NO.PRCHT1901	ART NO.PRCHT1902
Voltage	20V max	20V max
Motor type	#590	#775
Blade length	520 mm	550 mm
Strokes per minute	1200 spm	1200 spm

20V MAX / CORDLESS LONG POLE HEDGE TRIMMER

PRCGT2002

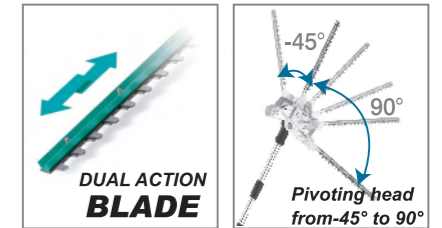
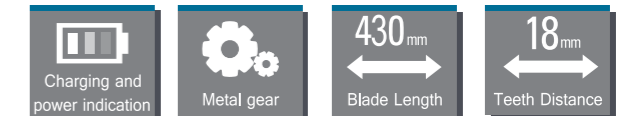

SPECIFICATION	ART NO.PRCGT2002
Voltage	20V max
Motor type	#590
Strokes per minute	1200 spm
Blade length	450 mm
Teeth distance	18 mm
Machine length	160-240 cm

20V MAX / CORDLESS BLOWER

PRCBL2301



PRCBL2302



SPECIFICATION	ART NO.PRCBL2301	ART NO.PRCBL2302
Voltage	20V max	20V max
Motor type	#775	#775
No load speed	0-18000 rpm	9300rpm (low) / 12000rpm (high)
Air speed	2.8 m ³ /min	Low: 172km/h High: 208km/h

20V MAX / CORDLESS PRESSURE WASHER

PRCHP2301A/B

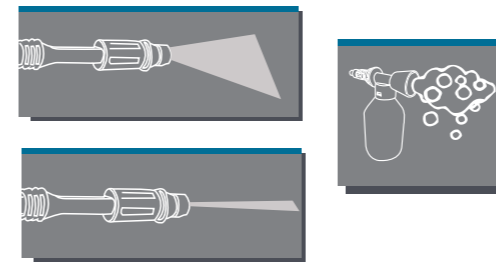

Multifunctional nozzle



5m water pipe



Soap bottle

Self-priming function

Works anywhere with fresh water source

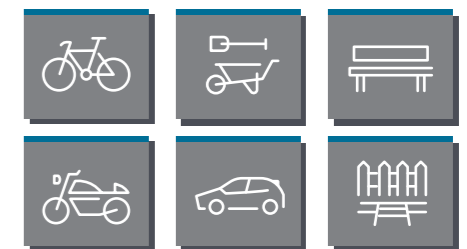

SPECIFICATION	ART NO.PRCHP2301A	ART NO.PRCHP2301B
Voltage	20V max	20V max
Motor type	#755	#755
Max. pressure (0.5mm nozzle)	25 bar	High:25bar, Low:17bar
Max. pressure (1.2mm nozzle)	14 bar	High:14bar, Low:9.8
Max working flow (0.5mm nozzle)	1.1 L/min	1.1 L/min
Max working flow (1.2mm nozzle)	2.7 L/min	2.7 L/min

40V MAX / CORDLESS CHAIN SAW

PRCCS4001

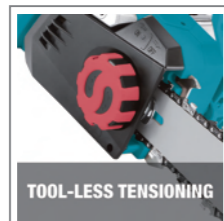
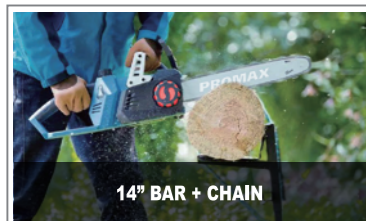
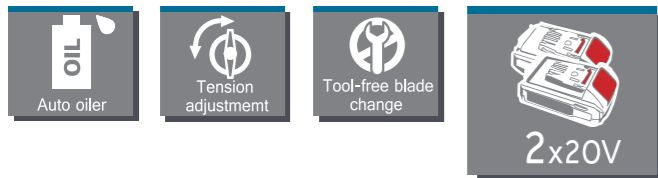

SPECIFICATION	ART NO.PRCCS4001
Voltage	40 V max (2x20V)
Bar & Chain	14" oregon
Chain speed	8.5 m/s
Rorate Speed	4500 rpm
Oil reservoir capacity	150 ml
Automatic Chain Oiler	YES
Tool Free Chain Tensioning	YES

40V MAX / CORDLESS BLOWER VACUUM

PRCBV4001



Transparent view window for observing inside and open it to clean inside

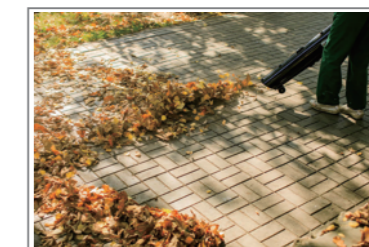

SPECIFICATION	ART NO.PRCBV4001
Voltage	40 V max (2x20V)
Motor	Brushless
Air speed	205 km/h
Suction power	235m³/h ~ 510m³/h
Rotate speed	5000-14000 rpm
Turbo Air speed	250 km/h
Turbo Suction power	630 m³/h
Turbo Rotate speed	16500 rpm
Shredding function	8:1
Capacity of catch bag	45 L

40V MAX / CORDLESS 2 in 1 BRUSH CUTTER

PRCBC4001

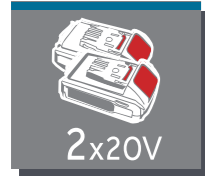
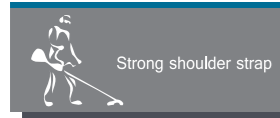
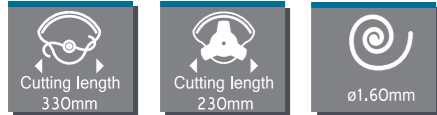

Brushless Motor



SPECIFICATION	ART NO.PRCBC4001
Voltage	40 V max (2x20V)
Motor	Brushless
No load speed	6000 rpm
Cutting length (Brush cutter)	230 mm
Cutting length (String trimmer)	330 mm
Line dia	ø1.6x6m dual line

40V MAX / CORDLESS LAWN MOWER

PRCLM4001

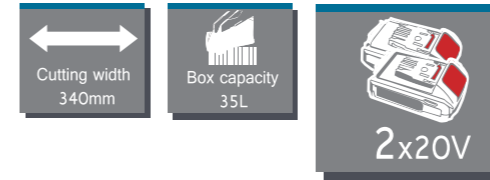

6 stage height setting



SPECIFICATION	ART NO.PRCLM4001
Voltage	40 V max (2x20V)
Motor	Brushless
Cutting width	340 mm
Working height	20-65 mm (6 levels)
No load speed	3000 rpm
Box capacity	35 L

40V MAX / CORDLESS SCARIFIER



Brushless Motor

PRCSC4001



SPECIFICATION	ART NO.PRCSC4001
Voltage	40 V max (2x20V)
Motor	Brushless
No load speed	2300 rpm
Raking width	360 mm
Scarifying depth	-7.5/-5/-3.5/2/9 mm
Box capacity	40 L

40V MAX / CORDLESS CULTIVATOR

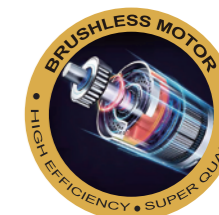

Brushless Motor

PRCCU4001

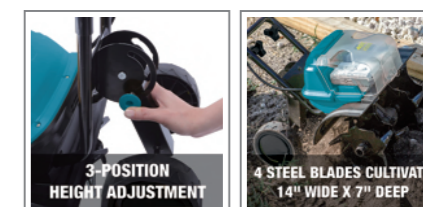

SPECIFICATION	ART NO.PRCCU4001
Voltage	40 V max (2x20V)
Motor	Brushless
No load speed	220 rpm
Cutting width	360 mm
Working height	180 mm

NOTE /

Ruled area on page 44 for taking notes, consisting of horizontal dotted lines.

Ruled area on page 45 for taking notes, consisting of horizontal dotted lines.